

# PRACTIKA 28 e 33



Caldaia a pellet dotata di serbatoio pellet remoto con capacità di circa 100kg e gruppo di caricamento (dotazione di serie). Disponibile in due potenze. Rendimento 90%



**RENDIMENTO TERMICO: SUPERIORE A 90%**

Possibilità di bruciare anche noccioli di olive o noccioli di ciliegia essiccati.

	Unità di misura	Practika 28	Practika 33
Potenza utile nominale	Kw	25	30
Potenza termica al focolare	Kw	27.5	33.3
Rendimento utile nominale	%	90	90
Rendimento utile al 30% del carico	%	91	91
Classe secondo EN303-5		3	3
Portata fumi	g/s	20	25
Temperature fumi	°C	200	200
Contenuto acqua caldaia	l	50	60
Portata sanitaria	l/min	---	---
Pressione massima di lavoro	bar	3	3
Dimensioni ( LxPxH )	mm	951x768x962	1011x768x1042
Peso caldaia	Kg	215	225
Diametro scarico fumi	mm	150	150
Capacità serbatoio pellet	Kg	100	100
Autonomia con una carica	h	25	20

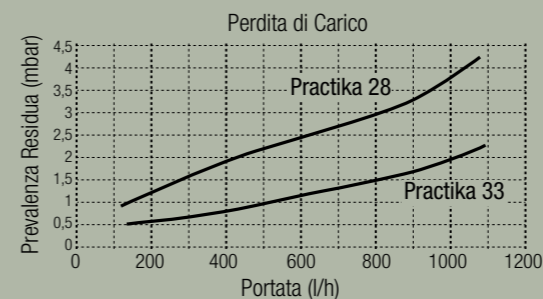

Lo schema evidenzia la diminuzione di pressione dell'acqua a seguito del passaggio attraverso la caldaia.

Elettronica programmabile che gestisce le funzioni della Caldaia.

Gruppo bruciatore esterno alla caldaia per una facile manutenzione e installazione (la caldaia può essere ordinata con predisposizione al montaggio del bruciatore sia a dx che a sx).

Braciere in acciaio inox ad alta resistenza.

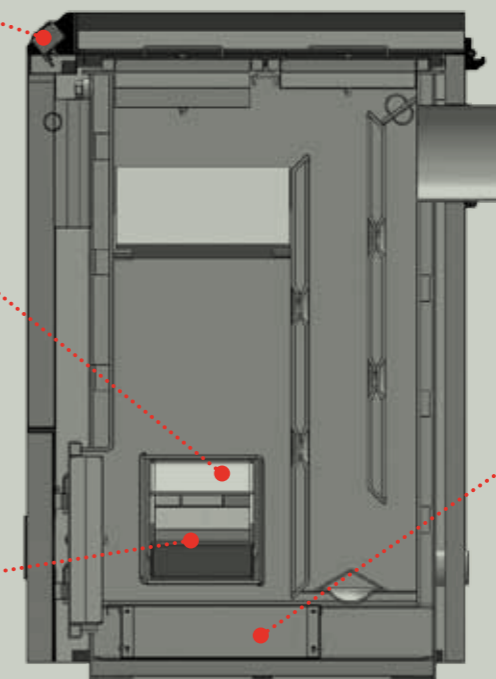

Serbatoio di caricamento dato in dotazione con capacità di circa 100Kg a richiesta può essere fornito il serbatoio da 200Kg e da 400Kg.

Capiente cassetto cenere per pulizie con frequenza settimanale.

PRACTIKA 28

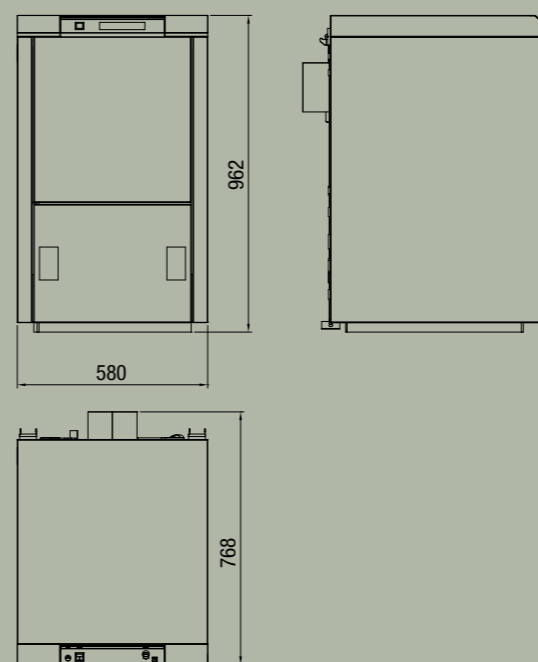

PRACTIKA 33

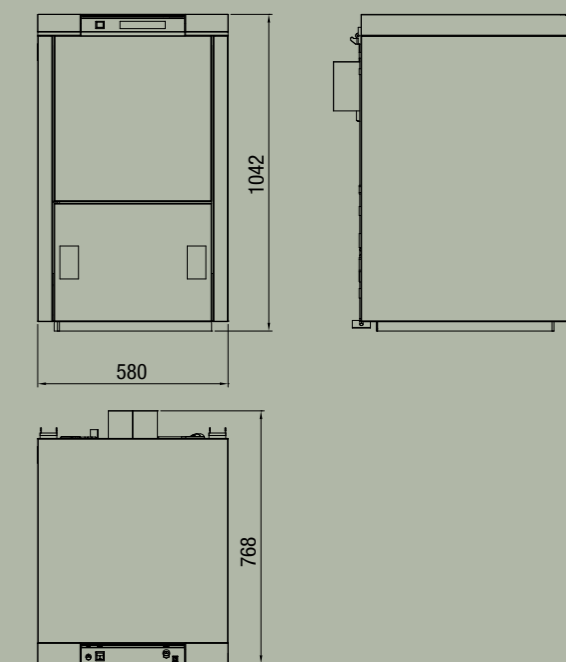

# PRACTIKA 28 and 33



Pellet boiler with remote pellet tank with a capacity of approximately 100 kg and filling unit (supplied as standard). Available with two power ratings. 90% efficiency



**HEATING EFFICIENCY: MORE THAN 90%**

Also designed to burn dried olive or cherry stones.

	Measurement unit	Practika 28	Practika 33
Nominal heat output	kW	25	30
Heat capacity in combustion chamber	kW	27.5	33.3
Nominal efficiency	%	90	90
Efficiency with 30% load	%	91	91
Class compliant with EN303-5		3	3
Fluegas mass flow	g/s	20	25
Smoke temperature	°C	200	200
Boiler water capacity	l	50	60
DHW flow rate	l/min	---	---
Maximum operating temperature	bar	3	3
Dimensions (WxDxH)	mm	951x768x962	1011x768x1042
Boiler weight	kg	215	225
Diameter of flue pipe	mm	150	150
Pellet hopper capacity	kg	100	100
Running time with one load	h	25	20

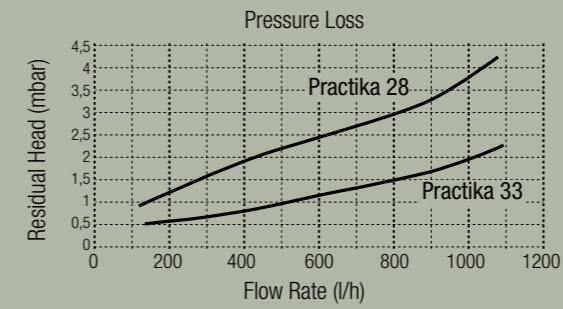

The diagram shows the drop in water pressure after flowing through the boiler.

Programmable electronics to control the boiler functions.

Burner unit outside the boiler for easy maintenance and installation (the boiler can be ordered designed for the burner to be mounted on the left or right).

High resistance stainless steel grate.

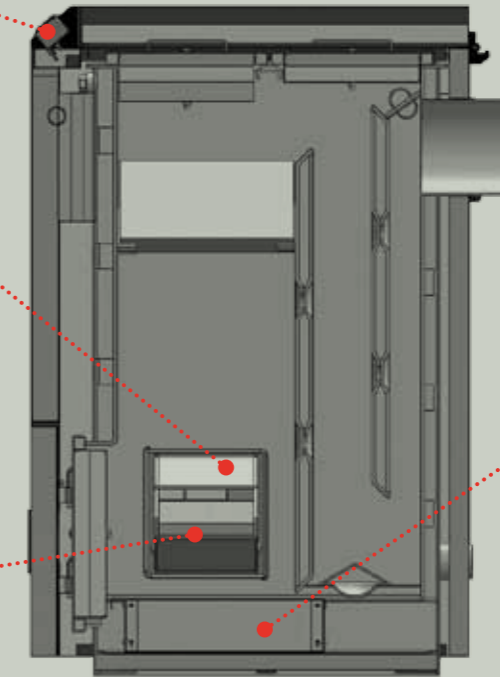

Filling hopper supplied as standard with a capacity of approximately 100 kg. A 200 kg or 400 kg capacity hopper can be supplied upon request.

Large ash tray for a weekly clean.

PRACTIKA 28

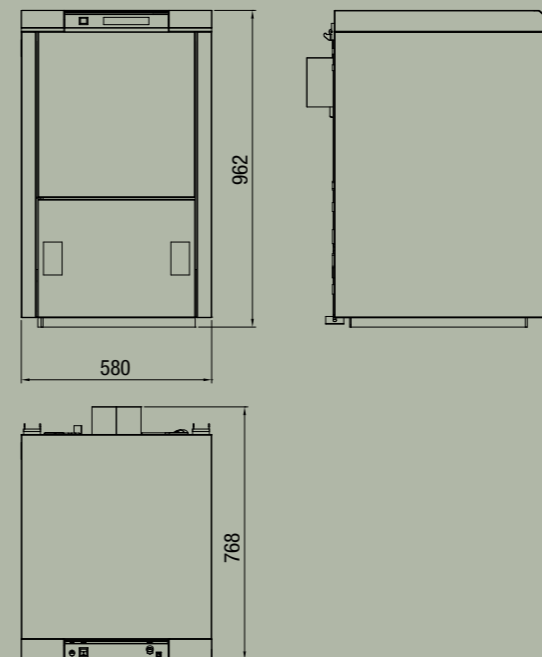

PRACTIKA 33

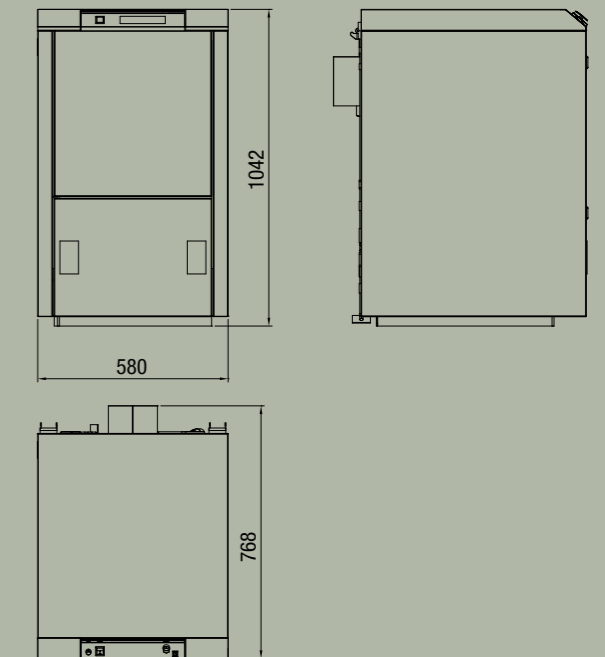

# PRACTIKA 28 et 33



Chaudière à pellets avec réservoir de pellets avec une capacité d'environ 100 kg et d'un groupe de chargement (fourni de série). Disponible en deux puissances. Rendement 90 %



**RENDEMENT THERMIQUE : SUPÉRIEUR À 90 %**

Possibilité de brûler également des noyaux d'olives ou des noyaux de cerise séchés.

	Unité de mesure	Practika 28	Practika 33
Puissance coté eau	Kw	25	30
Puissance thermique totale	Kw	27.5	33.3
Rendement utile nominal	%	90	90
Rendement utile à 30 % de la charge	%	91	91
Classe selon EN303-5		3	3
Débit des fumées	g/s	20	25
Température des fumées	°C	200	200
Volume d'eau de la chaudière	l	50	60
Débit eau sanitaire	l/min	---	---
Pression maximale de travail	bar	3	3
Dimensions (LxPxH)	mm	951x768x962	1011x768x1042
Poids de la chaudière	Kg	215	225
Diamètre de sortie des fumées	mm	150	150
Capacité du réservoir à pellets	Kg	100	100
Autonomie avec une charge	h	25	20

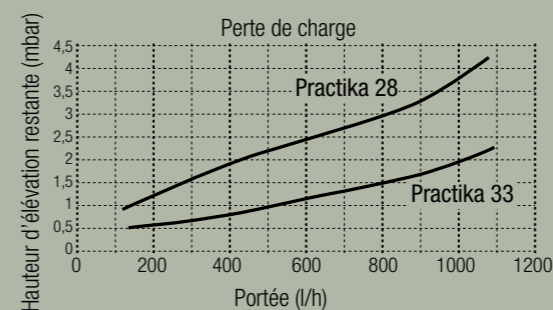

Le schéma met en évidence la diminution de pression de l'eau suite au passage à travers la chaudière.

Panneau électronique programmable qui gère les fonctions de la chaudière.

Groupe brûleur extérieur à la chaudière pour un entretien et une installation faciles (la chaudière peut être commandée avec un prééquipement pour le montage du brûleur tant à droite qu'à gauche).

Braséro en acier inox haute résistance.

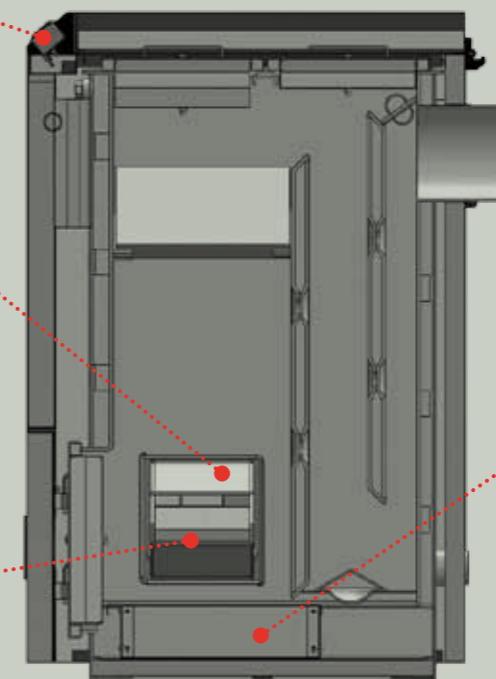

Réservoir de chargement fourni avec une capacité d'environ 100 Kg, en option, il est possible de fournir des réservoirs de 200 kg et de 400 kg.

Grand tiroir à cendres pour des nettoyages hebdomadaires.

PRACTIKA 28

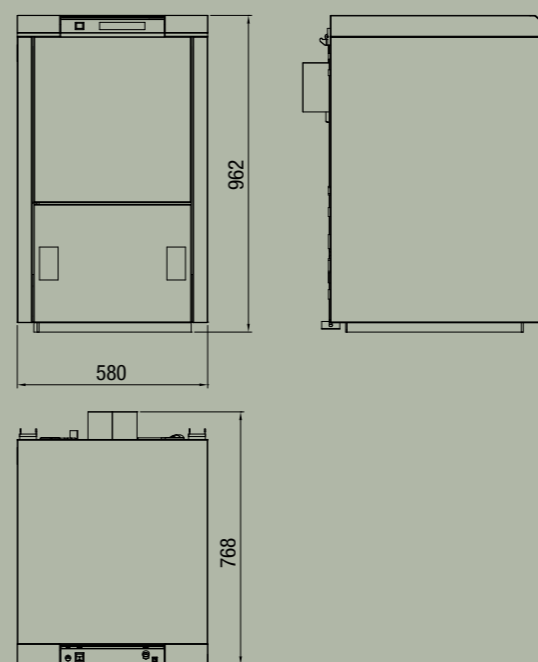

PRACTIKA 33

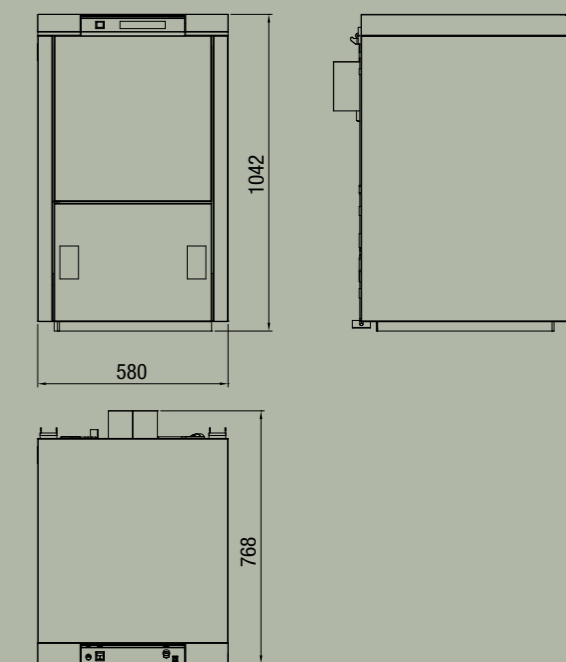

# PRACTIKA 28 und 33



Mit entfernt gelegentlichem Pellet-Behälter ausgestatteter Pellet-Heizkessel mit Beladungssystem (Serienausstattung) und einem Fassungsvermögen von etwa 100 Kg. Mit zwei Heizleistungen verfügbar. Energieeffizienz 90%



**THERMISCHE ENERGIE-EFFIZIENZ: ÜBER 90%**

Kann auch getrocknete Oliven- und Kirschkerne verbrennen.

	Maßeinheit	Practika 28	Practika 33
Nennnutzleistung	Kw	25	30
Nennwärmeleistung beim Feuerraum	Kw	27,5	33,3
Norm-Wirkungsgrad	%	90	90
Wirkungsgrad bei 30% der Beladung	%	91	91
Klasse nach EN 303-5		3	3
Abgasstrom	g/s	20	25
Abgastemperatur	°C	200	200
Wassergehalt Heizkessel	l	50	60
Sanitärwasser Förderleistung	l/min	---	---
Max. Betriebsdruck	bar	3	3
Maße: (BxTxH)	mm	951x768x962	1011x768x1042
Gewicht Heizkessel	Kg	215	225
Abgasrohrdurchmesser	mm	150	150
Fassungsvermögen Pellet-Behälter	Kg	100	100
Betriebsdauer mit einer Ladung	h	25	20

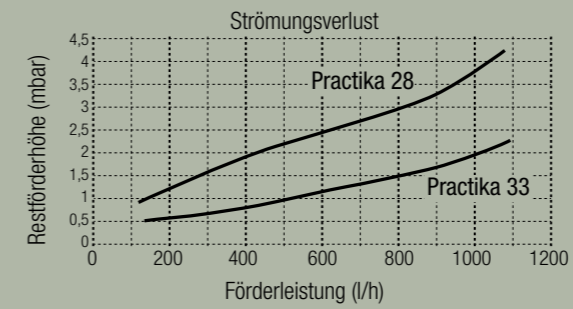

Das Schema verdeutlicht die Druckverringerung des Wassers nach dessen Zirkulation im Heizkessel.

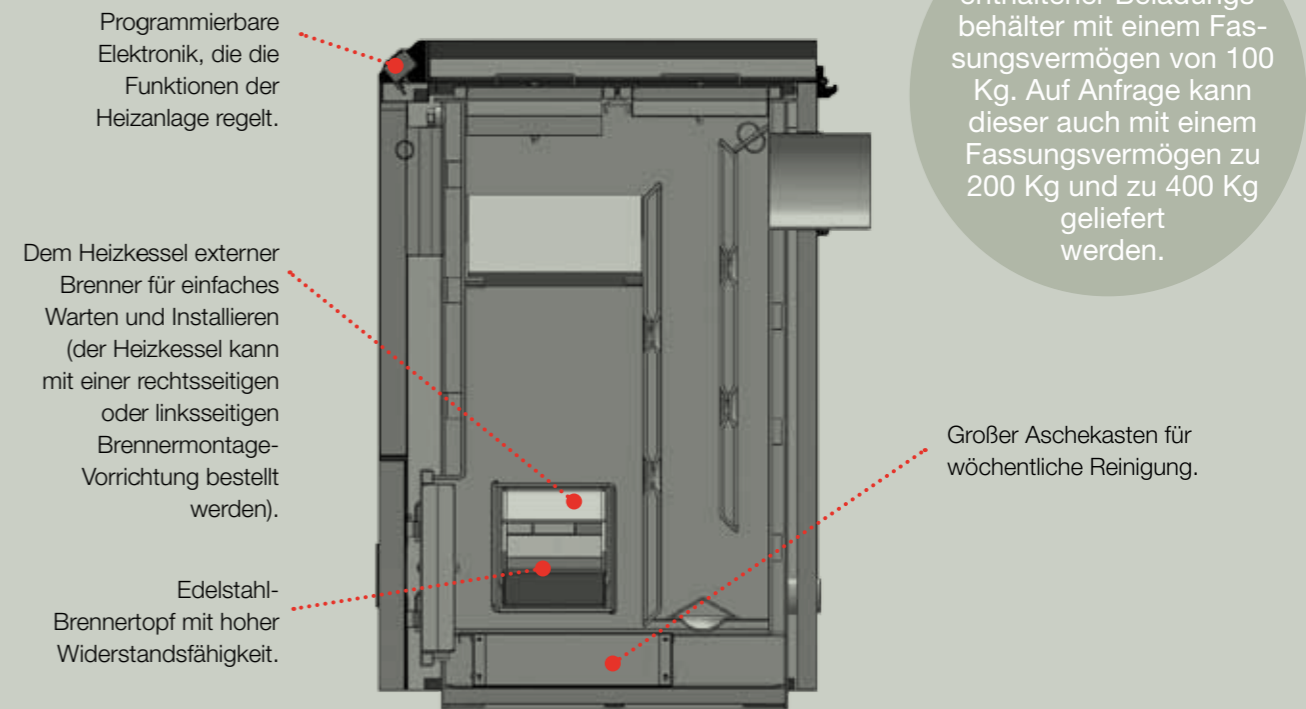

Im Lieferumfang enthaltener Beladungsbehälter mit einem Fassungsvermögen von 100 Kg. Auf Anfrage kann dieser auch mit einem Fassungsvermögen zu 200 Kg und zu 400 Kg geliefert werden.

PRACTIKA 28

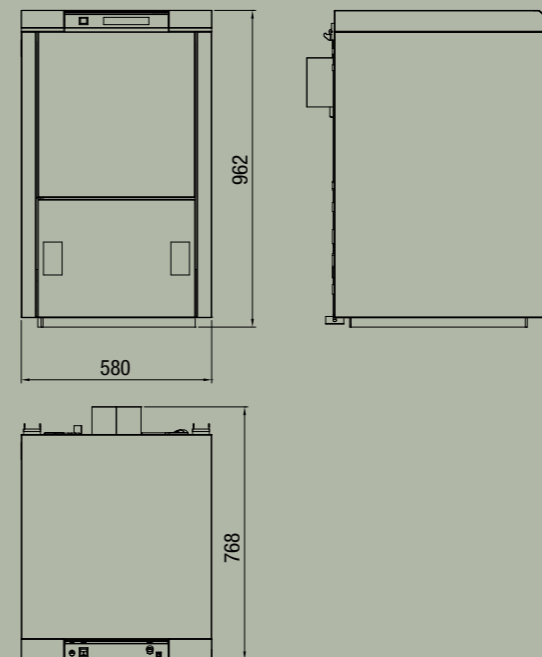

PRACTIKA 33

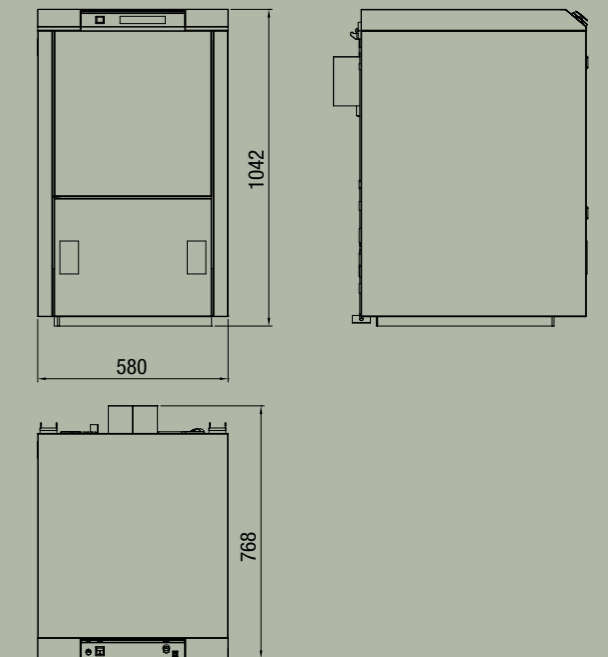

# PRACTIKA 28 y 33



Caldera a pellet dotada de depósito a pellet remoto con capacidad de unos 100 kgs y grupo de carga (suministrado de serie). Disponible en 2 potencias. Rendimiento 90%.



**RENDIMIENTO  
TÉRMICO:  
SUPERIOR AL  
90%**

**POSIBILIDAD  
DE QUEMAR  
TAMBIÉN HUESO  
DE ACEITUNA  
O DE CEREZA  
PREVIAMENTE  
SECADOS**

	Unidad de medida	Practika 28	Practika 33
Potencia útil nominal	Kw	25	30
Potencia térmica en el hogar	Kw	27.5	33.3
Rendimiento útil nominal	%	90	90
Rendimiento útil al 30% de carga	%	91	91
Clase según EN 303-5		3	3
Salida de gases	g/s	20	25
Temperatura de gases	°C	200	200
Capacidad de agua en la caldera	l	50	60
Agua sanitaria	l/min	---	---
Presión máxima de trabajo	bar	3	3
Dimensiones	mm	951x768x962	1011x768x1042
Peso caldera	Kg	215	225
Diámetro salida de humos	mm	150	150
Capacidad depósito de pellet	Kg	100	100
Autonomía con una carga	h	25	20

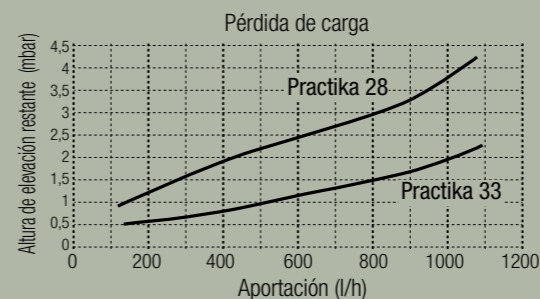

El esquema muestra la disminución de presión del agua después de pasar por la caldera

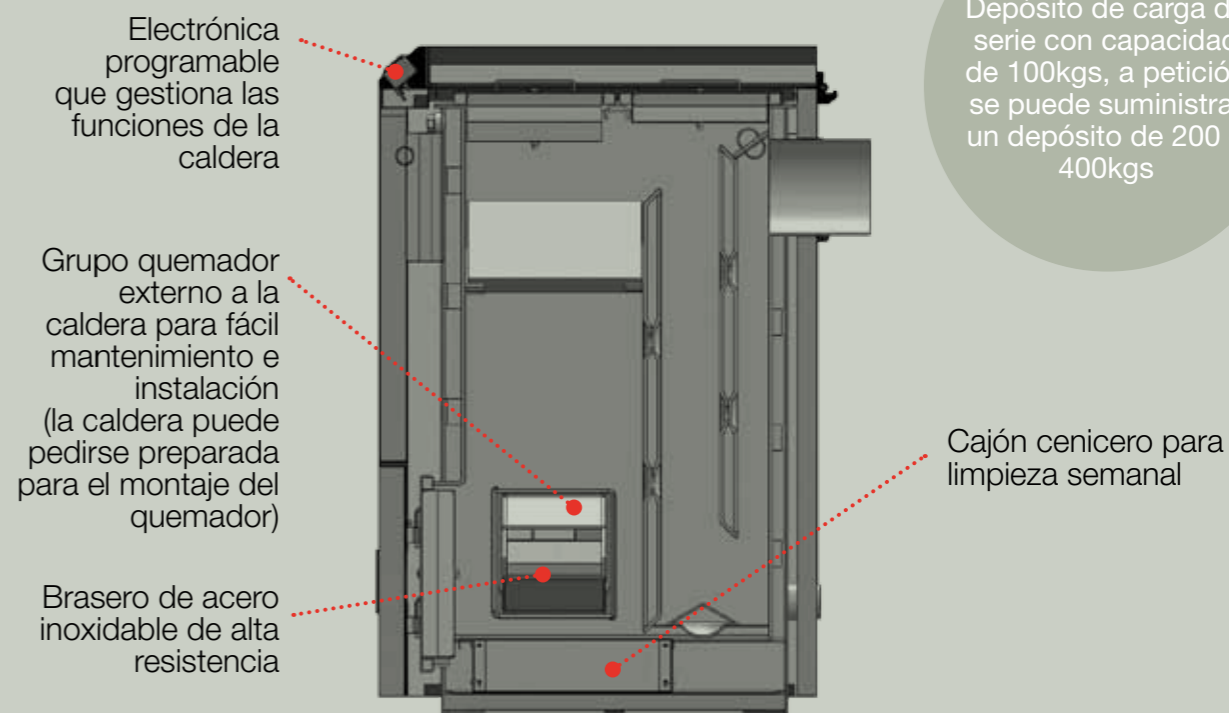

PRACTIKA 28

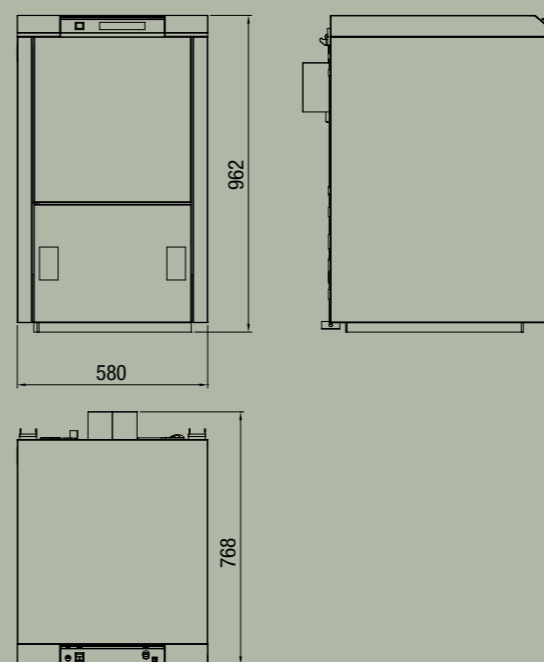

PRACTIKA 33

